

Model Number

Thermo Scientific TSX40086FA

Application and Rating

Application	Storage of General (non-flammable) Laboratory Materials
Storage Volume	19.31 cu. ft. (547 liters), 400 Standard 2" Boxes
Temperature Rating	-40°C to -86°C
Electrical Power	100V - 230V 50/60Hz
Instrument Rated Current	8.9A - 4.9A
Recommended Building Supply Rating	Type C circuit protection or similar required, Ensure compliance with local electric code
Power Plug / Power Cord	Country Dependent Plug / IEC Cords, 10 ft (3.05 m)
Agency Listings	UL, cUL, CE, ACT, Energy Star
Application Environment	Non-Corrosive, Non-Flammable, Non-Explosive Indoor Use Only, Ventilated 15 - 32°C (59 - 90°F)
Sound Pressure Level	43.6 dBA @ -80C Setpoint

Dimensions and Construction

Interior Dimensions (H x D x W)	51.2 x 28.3 x 23.1 in. (1300 x 719 x 587 mm)
Exterior Dimensions (H x D x W)	78 x 37.4 x 28.3 in. (1981 x 950 x 719 mm)
Shipping Dimensions	83 x 45 x 41.5 in. (2108 x 1143 x 1054 mm)
Shipping Weight / Net Weight	688 / 596 lbs (312 / 270 kg)
Insulation	Vacuum Insulation Panels with High-Density Water-Blown Polyurethane Foam, Electric Heater at Breaker Area
Door	Single Outer: Silicone-Based Gasket Seal Number of Inner: 2x Stainless Steel (5x Optional)
Shelves	3x Stainless Steel (4x Optional) Adjustable Shelves in 1" (25 mm) Increments
Shelf Capacity	Shelf: 150 / 165 lbs (68 / 75 kg) General / Rack Storage Cabinet Load not to Exceed: 1140 lbs (517 kg)
Interior / Exterior Wall Material	Painted Steel (Stainless Steel Optional) / Painted Steel
Casters	4x Standard All-Direction with Locks
Locking mechanism	Handle Key Lock and Pad Lock Loop Standard, HID Controlled Access Optional
Back Up Systems	LN2 or CO2 Optional

Electrical System Configuration

Power Switch	Soft-touch UI / Main Circuit Breaker (Behind Grill Door)
Controller Type	Capacitive Touch Screen Input and Display with USB Data Retrieval at Eye Level
Control Security	Setpoint Setting, User Log In Access
Compressor Safe Guard	High Temp Cutout Switch, Current, Logic protection
Control Sensor	Single RTD (1000 ohm Platinum RTD, class B, -196°C)
Remote Outputs	RS485, 4-20 mA Output, Remote Alarm Dry Contacts
Thermo Fisher Cloud	InstrumentConnect™ Compatible with Accessory
Adjustable Warm/Cold Alarms	Adjustable in 1°C Increments
Accessory Power	5V, POE

Refrigeration Configuration

Refrigeration System	Two Stage Cascade System
Compressor/Number	Variable Speed Industrial Rated, Hermetically Sealed / 2
Compressor Capacity*	938 W (max. speed)
Condenser Type	Enhanced Micro-Channel and Forced-Air Cooled
Expansion Device	Capillary Tube
Evaporator Type	Enhanced Cold Wall Design
Defrost Method	Manual Defrost
Refrigerant (1st/2nd Stage)	R290 / R170 + R290 Mix
Environmental Effects	GWP: 3 (R290) / 6 (R170) ODP: 0 (R290); 0 (R170)
Flammable	Yes

Dimensions in inch [metric in: mm]

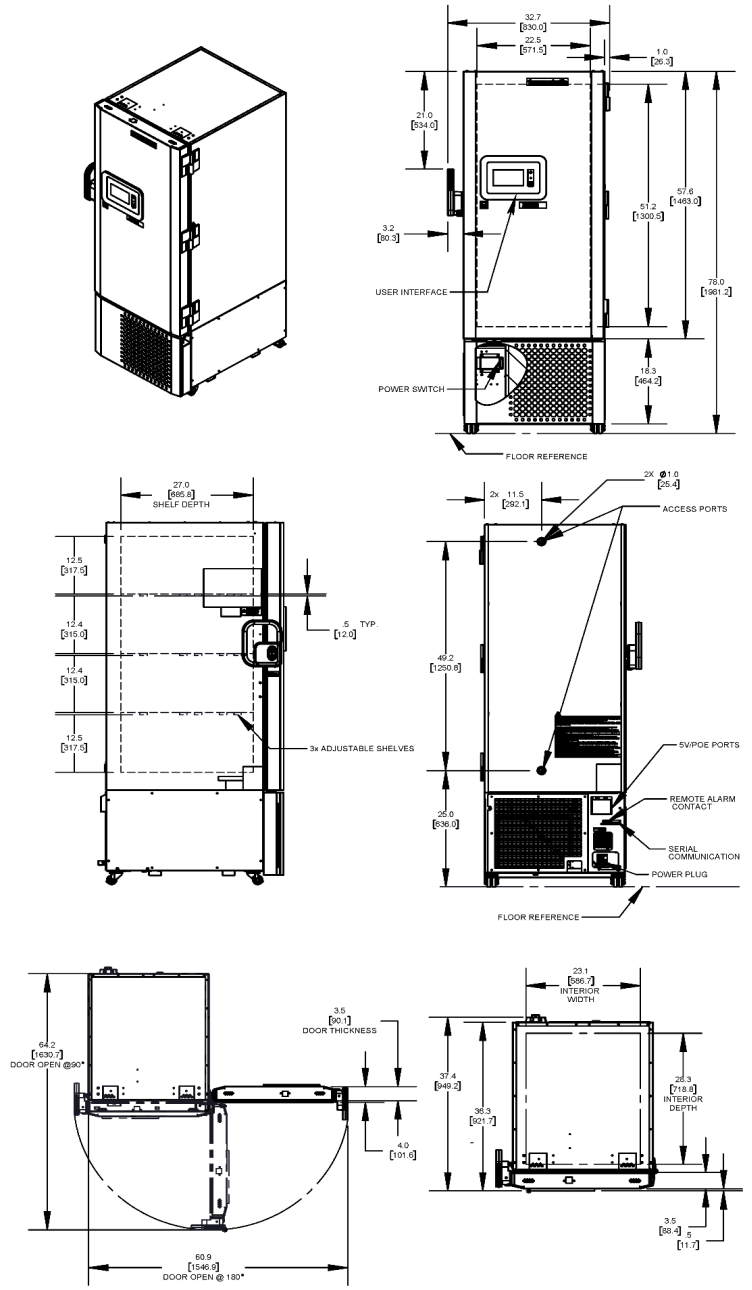

1) Data is representative of performance and not published product specifications. Technical data sheet test results should not be referenced in developing any regulatory parameters for specific customer usage.
 2) Freezer performance will vary based on customer product volume, storage format, options selected, operating conditions, test methodology and performing recommended maintenance.
 3) Continuous product enhancements may, without notice, result in amendments or omissions to this technical data sheet. Thermo Scientific cannot accept responsibility for damage, injury, loss or expenses resulting from misapplication of the information herein.



Performance Data Sheet -80°C Setpoint
Thermo Scientific Ultra-Low Temperature Freezer
 Upright Model Release - 90
 Thermo Fisher Scientific, Asheville, North Carolina

ENERGY STAR®
 (Daily Energy Consumption)



0.36 kW-hr/day/cuft

Model Number

Thermo Scientific TSX40086FA

Performance

Ambient	°C	20	24
Energy Consumption	kWh/day	7.8	8.6
Heat Rejection Rate	Btu/h	1109	1223
Peak Variation from Setpoint	°C	-3.3/+0.7	-3.4/+1.0
Average Uniformity	°C	3.7	4.1
Average Stability	°C	0.2	0.2
Average Cabinet Temperature	°C	-81.7	-81.6
1-min Door Opening Recovery to -75°C	min	11.4	16.2
Pull Down Time to -80°C	min	232	245
Warm Up Time -80°C to -50°C	min	261	232

Pull Down and Warm Up at 20°C and 24°C Ambient

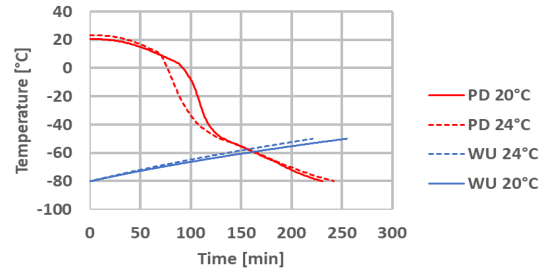

Cabinet Temperature Distribution [°C]

20°C Ambient

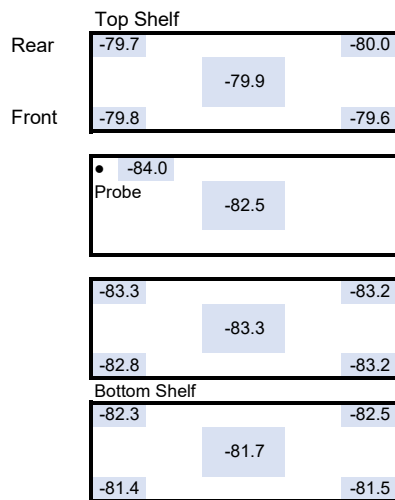

20360-B-26

24°C Ambient

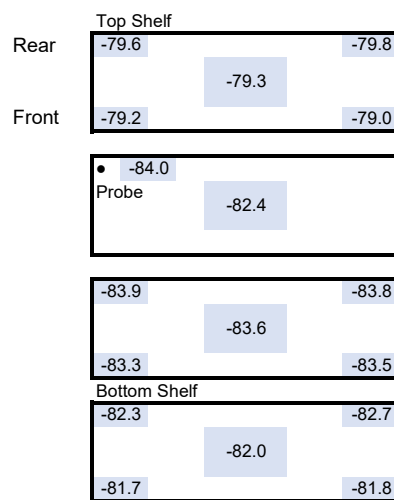

20360-B-26

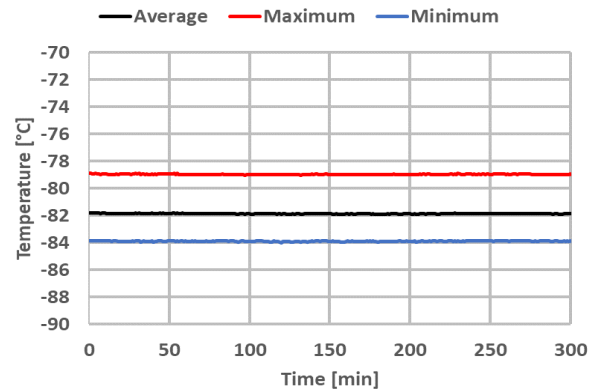
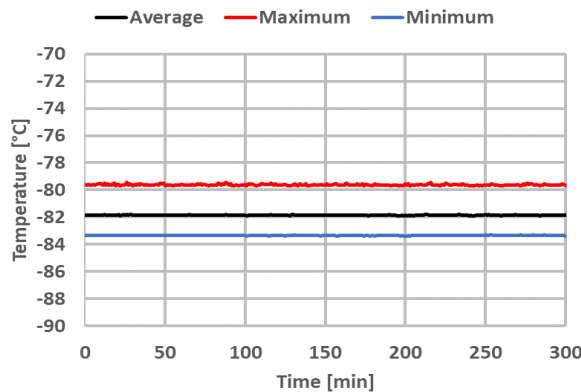

1) Data is representative of performance and not published product specifications. Technical data sheet test results should not be referenced in developing any regulatory parameters for specific customer usage.
 2) Freezer performance will vary based on customer product volume, storage format, options selected, operating conditions, test methodology and performing recommended maintenance.
 3) Continuous product enhancements may, without notice, result in amendments or omissions to this technical data sheet. Thermo Scientific cannot accept responsibility for damage, injury, loss or expenses resulting from misapplication of the information herein.
 4) Actual temperature measurement will vary based on type and location of the probe used.



Performance Data Sheet Warm Setpoints
Thermo Scientific Ultra-Low Temperature Freezer
 Upright Model Release - 90
 Thermo Fisher Scientific, Asheville, North Carolina

ENERGY STAR®
 (Daily Energy Consumption)



0.36 kW-hr/day/cuft

Model Number

Thermo Scientific TSX40086FA

Performance

Ambient	°C	20				24			
		-70	-60	-50	-40	-70	-60	-50	-40
Setpoint	°C	-70	-60	-50	-40	-70	-60	-50	-40
Energy Consumption	kWh/day	4.9	4.1	3.4	2.9	5.5	4.5	3.8	3.2
Heat Rejection Rate	Btu/h	697	583	483	412	782	640	540	455
Peak Variation from Setpoint	°C	-3.8/+2.6	-4.3/+2.1	-3.9/+3.3	-6.2/+8.0	-3.5/+2.8	-4.2/+2.4	-4.0/+4.0	-5.5/+8.7
Average Uniformity	°C	3.6	3.3	5.4	8.4	3.6	3.4	6.2	8.6
Average Stability	°C	2.0	2.3	2.0	3.8	1.6	2.0	1.7	3.3
Average Cabinet Temperature	°C	-71.2	-61.6	-50.8	-37.6	-71.0	-61.5	-50.6	-37.2

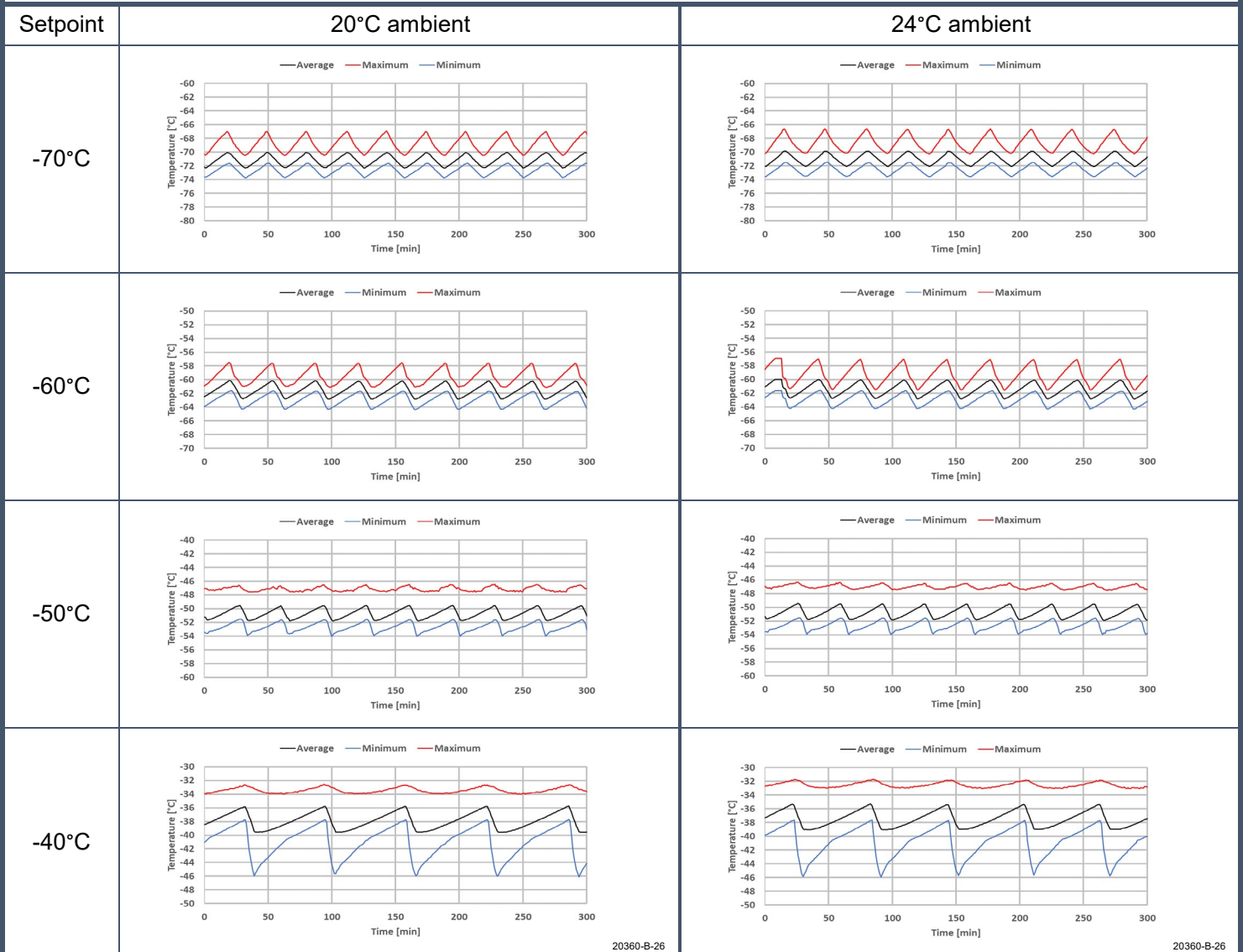

20360-B-26

20360-B-26

1) Data is representative of performance and not published product specifications. Technical data sheet test results should not be referenced in developing any regulatory parameters for specific customer usage.
 2) Freezer performance will vary based on customer product volume, storage format, options selected, operating conditions, test methodology and performing recommended maintenance.
 3) Continuous product enhancements may, without notice, result in amendments or omissions to this technical data sheet. Thermo Scientific cannot accept responsibility for damage, injury, loss or expenses resulting from misapplication of the information herein.
 4) Actual temperature measurement will vary based on type and location of the probe used.